

# *Make Your Own* **LIGHT BULBS**

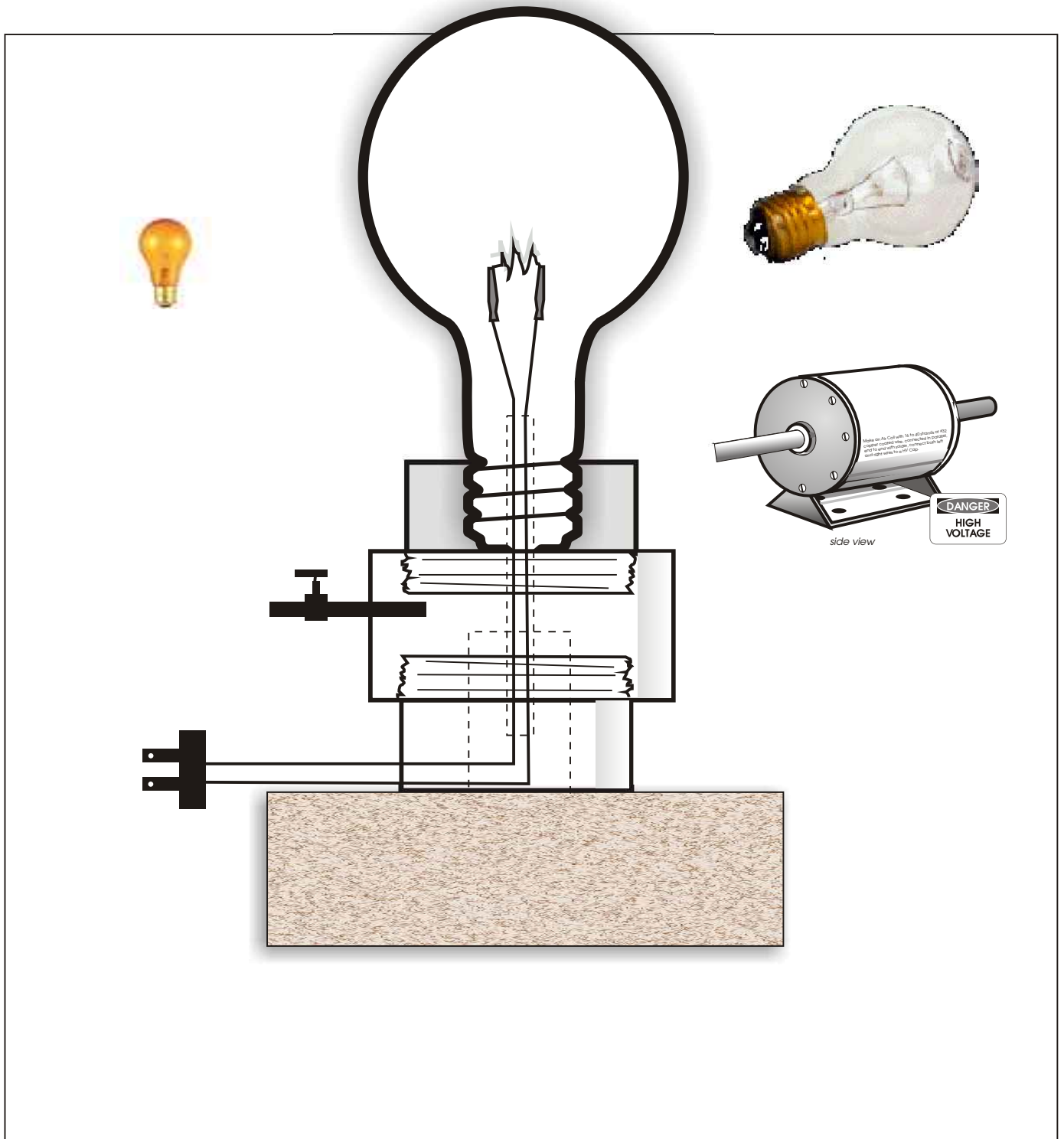

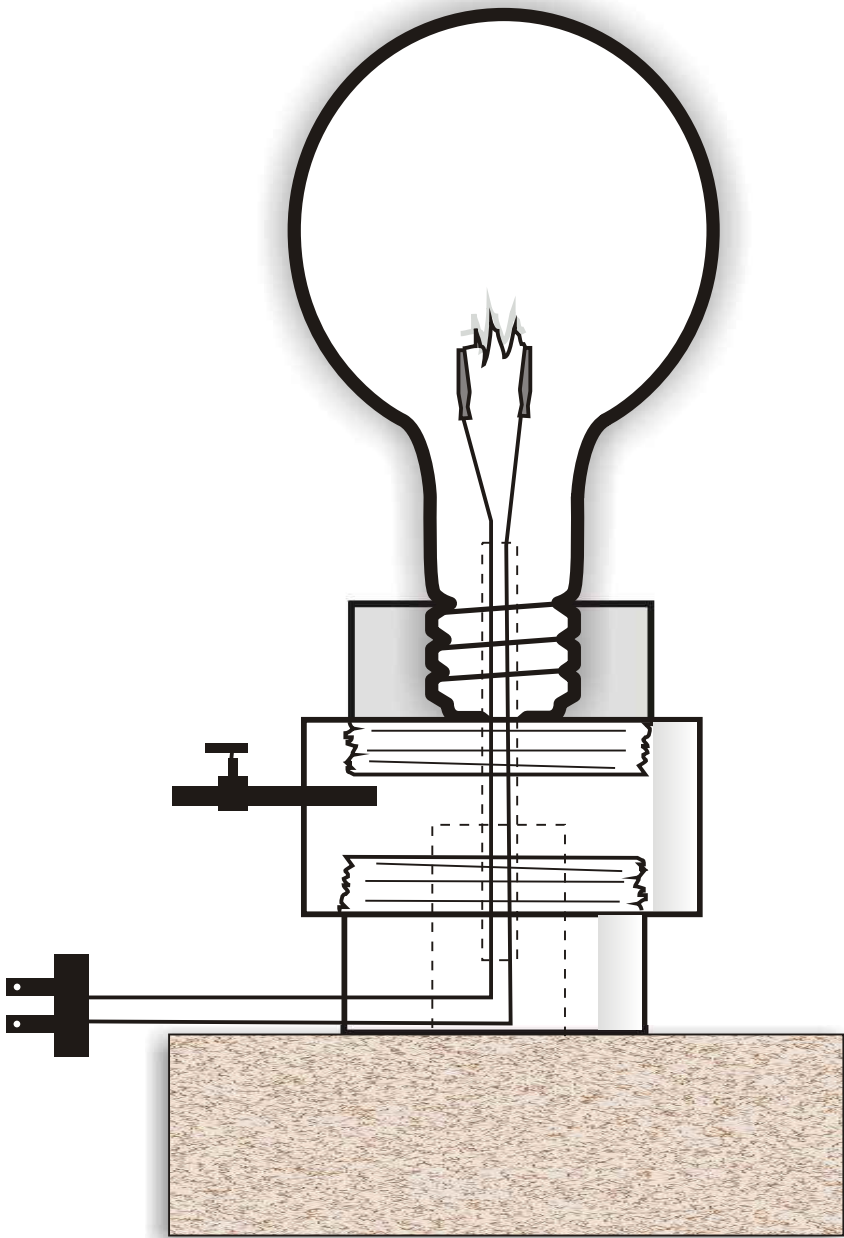

You can make your own long lasting light bulbs by redesigning the bulb and the casing and making the filament interchangeable. The bulb simply screws on and off so when it does burn out you can reconnect the old one or find another filament from an old burnt out light bulb and use it. The filament attaches with 2 small copper or steel alligator clips.

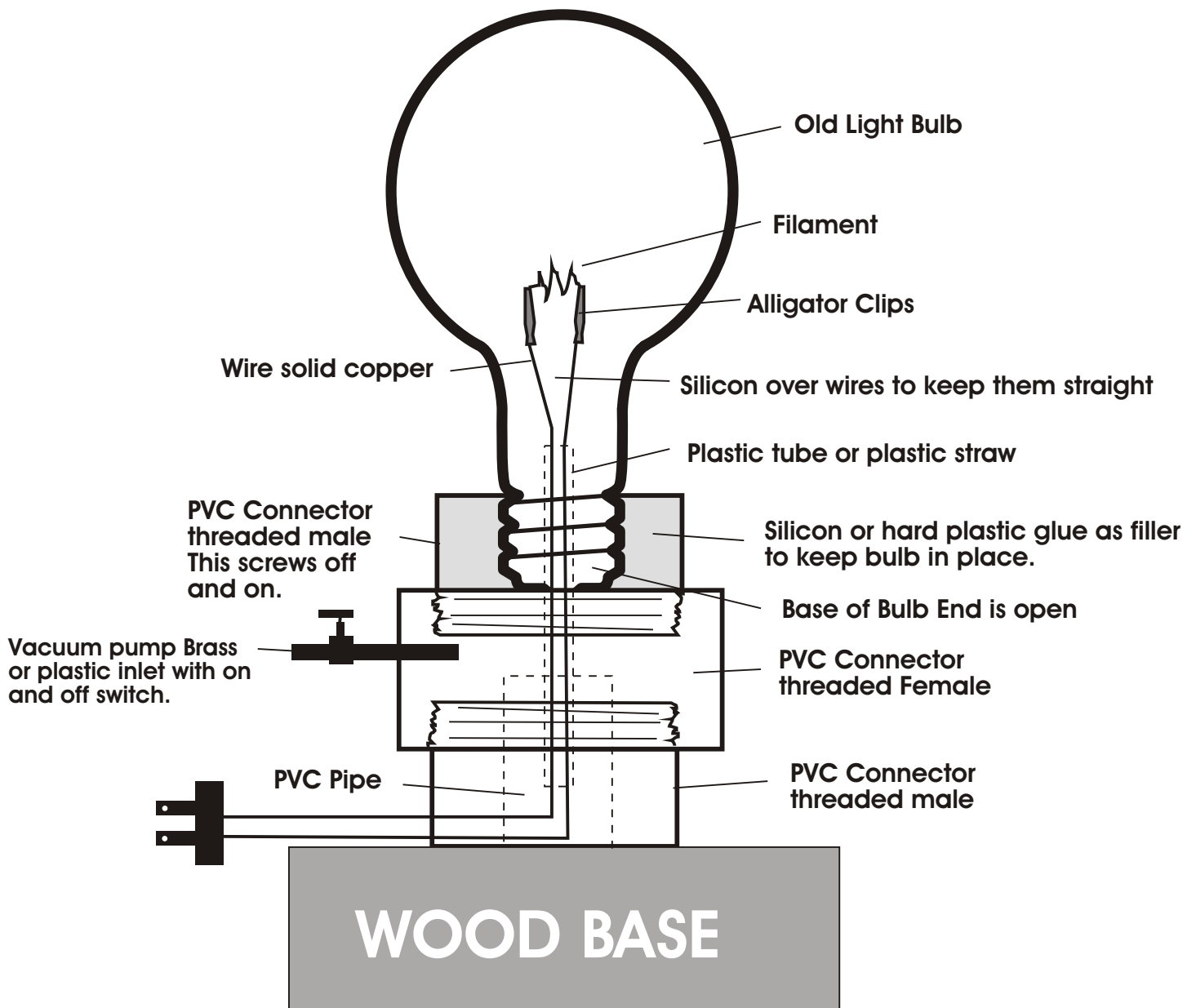

Before we start we will explain how to use it,

Unscrew the bulb by placing your finger's on the PVC base #1, Not the bulb itself or you may loosen it and bulb could come off or you will lose vacuum pressure. Next, slowly pull the entire bulb assembly upward and off. be careful not to snag onto the alligator clips. Now reuse the old filament or change to a new one from an old burnt out light bulb. place filament on alligator clips, make sure there is contact. now before you put the old bulb assembly back on you must re-tape if the pipe with pipe thread if needed, you may be able to still use the old tape already on there.

Now very carefully put bulb assembly back onto the base by screwing it in. ( Make sure there is no vacuum pressure leaks if there is the filament will not burn long, there must not be no air or oxygen inside.)

Now once Bulb assembly is in screwed into place then turn the vacuum pump on/off inlet to on position. Use a old fish tank pump as a vacuum (you will have to do some adjustment to it.) or buy you a small inexpensive vacuum pump at a hobby store. Now turn on the pump and pump out all the air, it should only take about 3 to 4 seconds.

**Warning: DO NOT OVER VACUUM IT CAN BREAK THE GLASS BULB AND CAUSE BODILY INJURY'S.**

After 3 to 4 seconds turn off valve. Now plug in the bulb in a 115 volt ac outlet. Bulb will light up! If it lights up then burns out a short time later then vacuum out air a little longer, Use your own judgment. It is recommended that you use a pressure gauge, and also please wear protective goggles and clothing in case of breakage.

# Assembly

First find an old burnt out 100 watt light bulb or you can use a glass jar or drinking glass, Use a Hack saw to saw the tip off of the light bulb bottom so the bottom is open, Now break everything out of the filament area, Be careful not to break bulb. Next, use a PVC threaded male piece ( Which you can buy at any hardware store ) and place it on a piece of wax paper on a flat surface, Place the bulb in the center of it, let bulb go all the way to the flat surface of the table, (Not shown in other drawings) now using masking tape tape bulb so it will not move as so, apply first layer of silicon or body putty then add sand to 2nd layer or paper as a filler, then 3rd layer add more silicon or body putty which ever you would like to use. Now let it dry and stand over night.

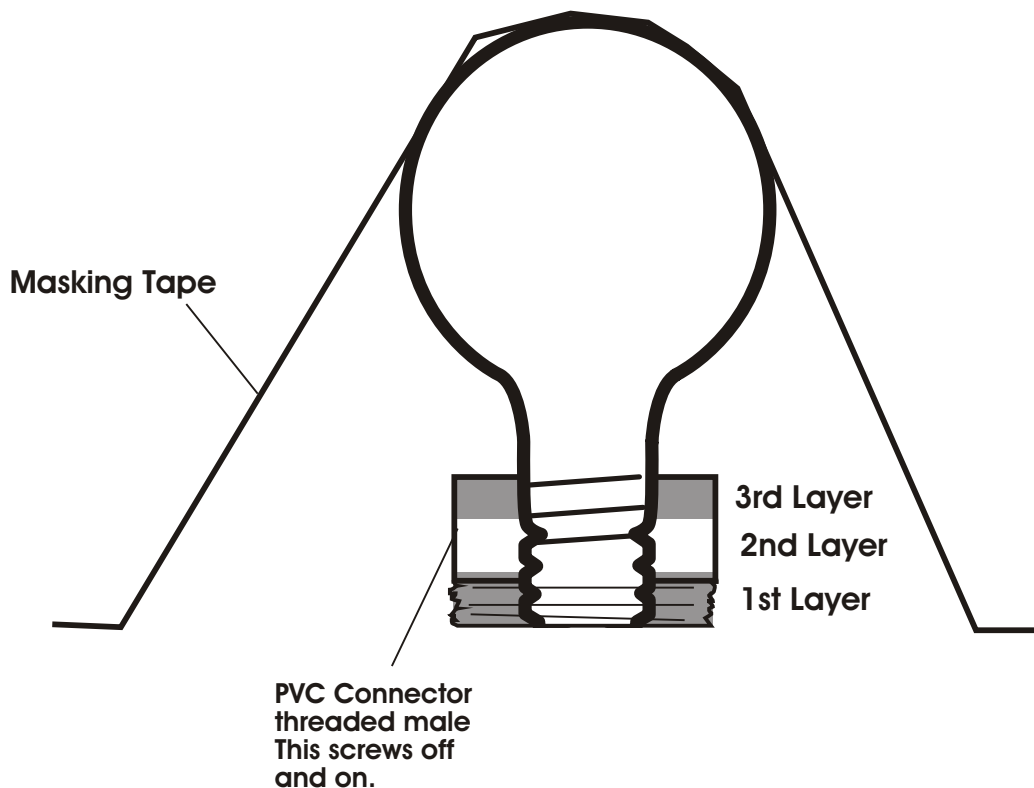

Take #3 and #5 Pvc and attach with PVC Glue. Then drill 4 holes in #5 cap that is attached to #3, These are your wood screw holes, Now attach #3 & #5 to wood base with wood screws.

Now take #4 and center it in the middle of #3 PVC, Then use silicon or body putty to keep it in place. #4 PVC can have a threaded lid that comes off and on, so if you need to take apart to replace wiring you can. the PVC or straw will glue to a drilled hole thru that lid, then wiring can be lead thru base and straw,

and adjustment made if needed. Now apply pipe tape to #3 PVC male piece. and then attach #2 Female PVC threaded. to #3. Now the vacuum pump inlet you can get at the hardware store you can use a small brass inlet on/off valve formally used for natural gas. use your imagine nation, just make sure it does not leak , That it will hold the pressure then solder 2 alligator clip to the ends of the insulated solid copper wire, then guide wire thru to #3 PVC and out its predrilled hole side. Then connect a 6 foot cord onto it, and then attach wall plug. Good luck, and have fun. Experiment with homemade filaments.

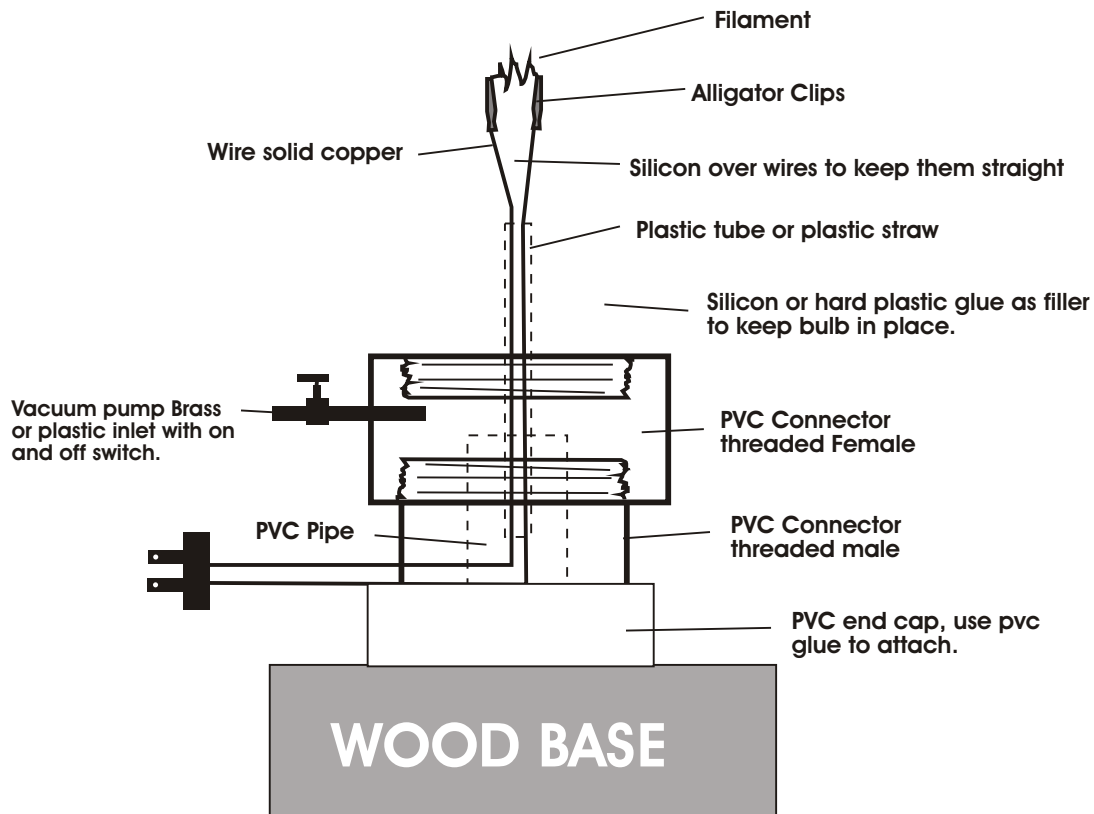

**WARNING HIGH VOLTAGE; 115 vAC house current can kill you be careful make evrything is connected properly before plugging into the wall outlet of your house.**

You can use an old glass jar or drinking glass instead of a old burnt out bulb, Glass jars are a lot easier to work with.  
it is optional but you can use a small candle to take the air out of the jar instead of a vacuum device.

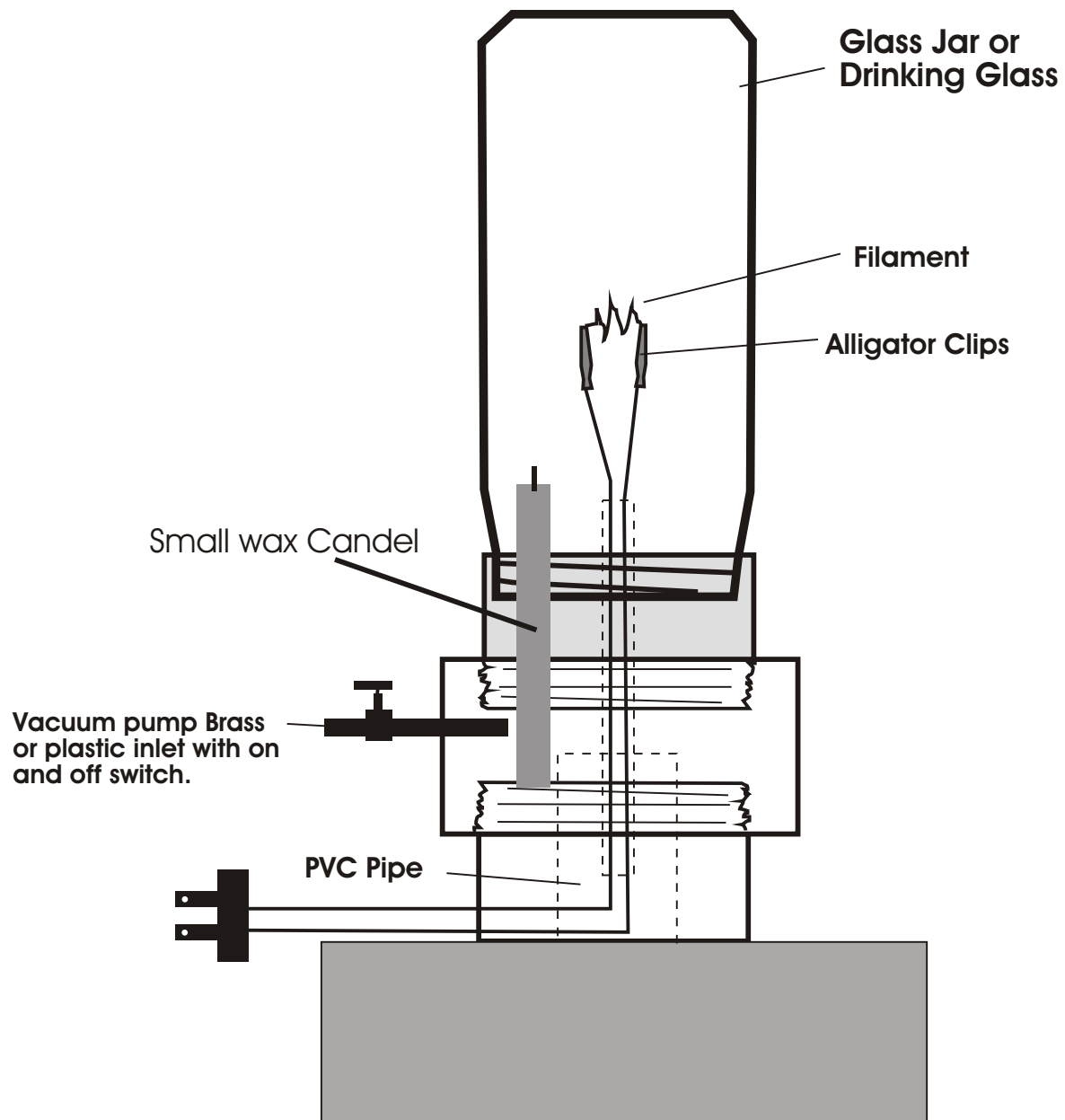

## What? Thomas Edison Did not invent the light bulb? .

Contrary to what schools have taught for many years, **Thomas Edison**, did not invent the light bulb, nor did he hold the first patent to the modern design of the light bulb.

It seems we gave Mr. Edison credit for the invention solely because he owned a power company, later known as **General Electric**,

Light bulbs used as electric lights existed 50 years before Thomas Edison's 1879 US patent.

It was **Joseph Swan**, a British inventor, who obtained the first patent for the same light bulb in Britain one year before **Edison's** patent date. Swan showed many people his carbon filament light bulb in New Castle, England about 10 years before Edison shocked the world with the announcement that he invented the first light bulb. The fact was, Edison's light bulb was a carbon copy of Swan's light bulb invention.

Swan's light bulb invention was shown in a magazine called Scientific American.

Without a doubt, Edison had access to, and eagerly read this article. Giving Mr. Edison the benefit of the doubt, and stopping short of calling him a thief, we can say that he invented the light bulb by making vast improvements to Swan's published, yet unperfected designs.

Swan, was very angry with Edison as he watched him make a load of money from his invention. He took Edison to Court for patent infringement. The British Courts stood by their patent award for the light bulb to Swan, and Edison lost.. The British Courts forced Edison, as part of the settlement, to name Swan a partner in his British electric company. Eventually, Edison managed to buy all of Swan's interest in the new company that was now renamed **Edison and Swan United Electric Company**.

**Edison did** no better back home in the U.S. the U.S. Patent Office ruled, on October 8, 1883, that Edison's patents were invalid, because he based them upon the earlier art of a gentleman named William Sawyer. To make matters worse, Swan then sold his U.S. patent rights, in June 1882, to **Brush Electric Company**. This stripped Edison of all patent rights to the light bulb, and left him with no hope of purchasing any.

**Edison** dusted himself off, and went into business setting up a direct current (DC) power company in New York City, and selling Swan's light bulbs that used this electricity. The light bulb business flickered between 1879 and 1889, Edison's customer base rapidly expanded to three million customers over the span of 10 years.



### I'll Bet You Didn't Know,

The first light bulbs lasted only 150 hours, and then ten years later, Edison introduced one that lasted 1,200 hours? The average light bulb today lasts about 1,500 hours. You could build one that last longer.



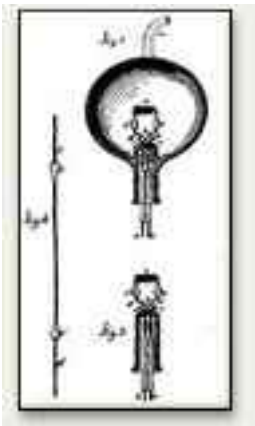

Carbon Lamp

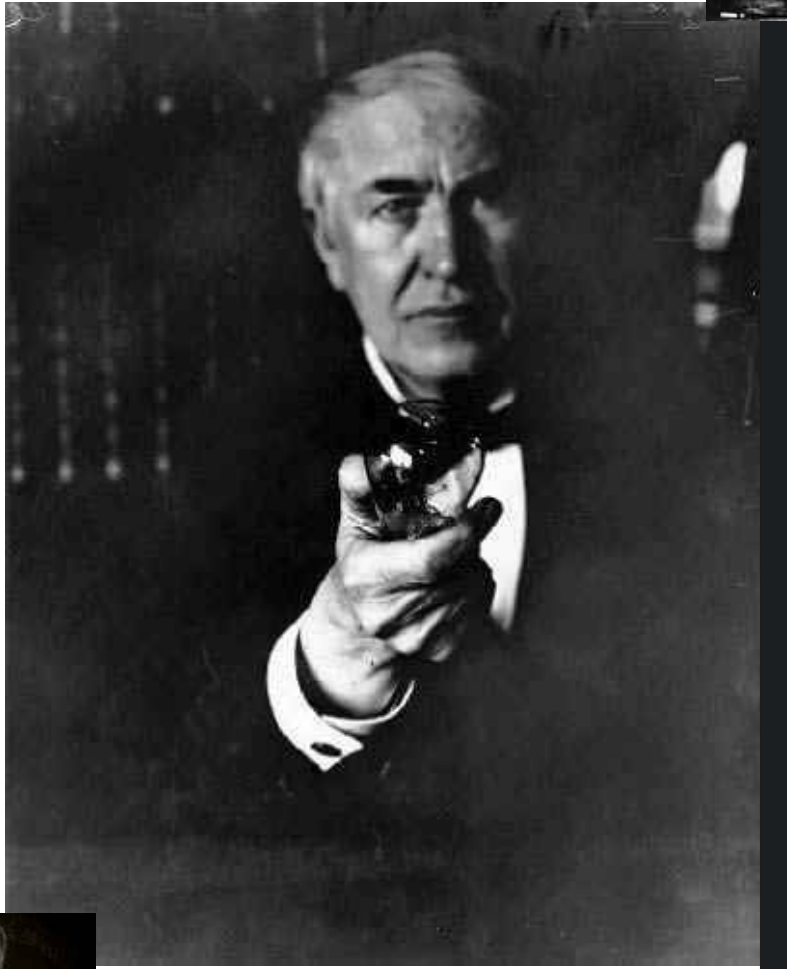

## Edison

Edison seemed to make many enemies, and Nikola Tesla was one of them. Tesla tried to tell Edison that his AC inventions would work much better than Edison's DC current inventions.

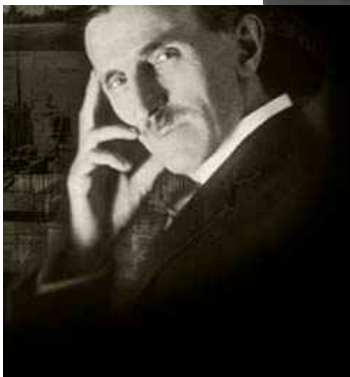

## Tesla