



Scale up the enclosed methods and you could have

Unlimited Amperage!

By Unlimited we mean you can keep adding more earth cells to your earth power station as you can afford it year by year adding more and more amp power.



Aluminum



Copper

There are many ways to pick up on the free energy in the earth, Just a few are described in these plans. These devices if made right will pick up earth energy that many call ether or static currents as well as acting as high efficient earth battery's. Ether travels through plastic wood etc... Study and research these plans closely there is more to these plans than what you may think. You can learn to get enough power to run your home!

Learning The basic's of the invention

Experiment #1 How to assemble a 12 vdc system

1. You will have 12- 4" 3/4" copper piping, or If you did not purchase the kit then cut your copper to this size. KIT: take each piece of copper and tape the tops with 1" masking tape.

2. Now using RED LACQUER spray paint (Which you can buy at any hardware store), Paint the outside of the copper all around. (DO NOT PAINT THE INSIDE.) let air dry for 24 hrs. Now remove 1" masking tape.

3. Take the copper pipe outside to the area that you are going to use. use a hammer and hammer each one Into the ground up to the 1" copper exposed top. do not let the exposed copper touch the earth in the final placement. Dirt should be moist. Not real dry.

4. Now remove each pipe and place a thick piece of plastic on bottom of copper pipe to cap it. LET IT BE LOOSE, DO NOT TAPE IT. YOU WANT RAIN WATER TO BE ABLE TO ESCAPE FROM EACH PIPE, Do not let exposed outside copper touch the earth.

5. Now hammer each pipe back Into the same holes. place each 2" piece of zinc rod (or a long bolt, most bolts are zinc plated) into the center of each pipe. The zinc Is the NEGATIVE and the copper is the + POSITIVE.

6. Now connect them in series to get 12 volts, use clip wire or solder them. If you are going to leave It outside for a long time then make sure connections are soldered and then painted to protect them from the weather. The rain will replenish your earth batteries. Top get more amaperage with this type simply add more copper and zinc rod cells USE 3' PIECES OF COPPER PIPE INSTEAD OF 4" PIPE. THEN CONNECT EVERY ROW OF 12 PIPES IN PARALLEL.. ADD AS MANY ROWS AS YOU NEED UNTIL YOU GET THE DESIRED AMPERAGE YOU WANT. (**THINK BIG!**) This can be a very powerful free energy system for your home or other. Not only will you get an earth battery effect, but you will also be collecting earth currents from ether /static and under ground radio waves as well.

7. The deeper you go with the copper pipe, the more amperage and voltage you can get.

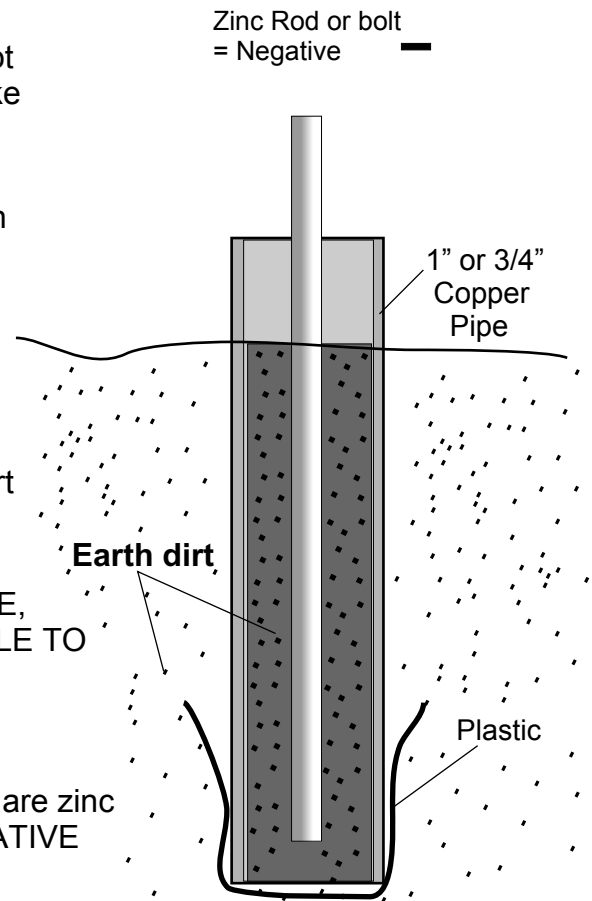

1" Copper = +
Positive 1.5 vdc
each cell you make

This represents one
cell. A qty of 12 to 14
will give you 12 - 14 volts dc
when connected in series.

Cut 12 - 4" L x 3/4"
copper pipe

Learning The basic's of the invention

Experiment #2 How to assemble a 12 vdc system

This is just an example to go by and is not the best way but is low in efficiency! See our capacitor earth cells, coil type or flat sheet type. They produce far more amperage and voltages than this type.

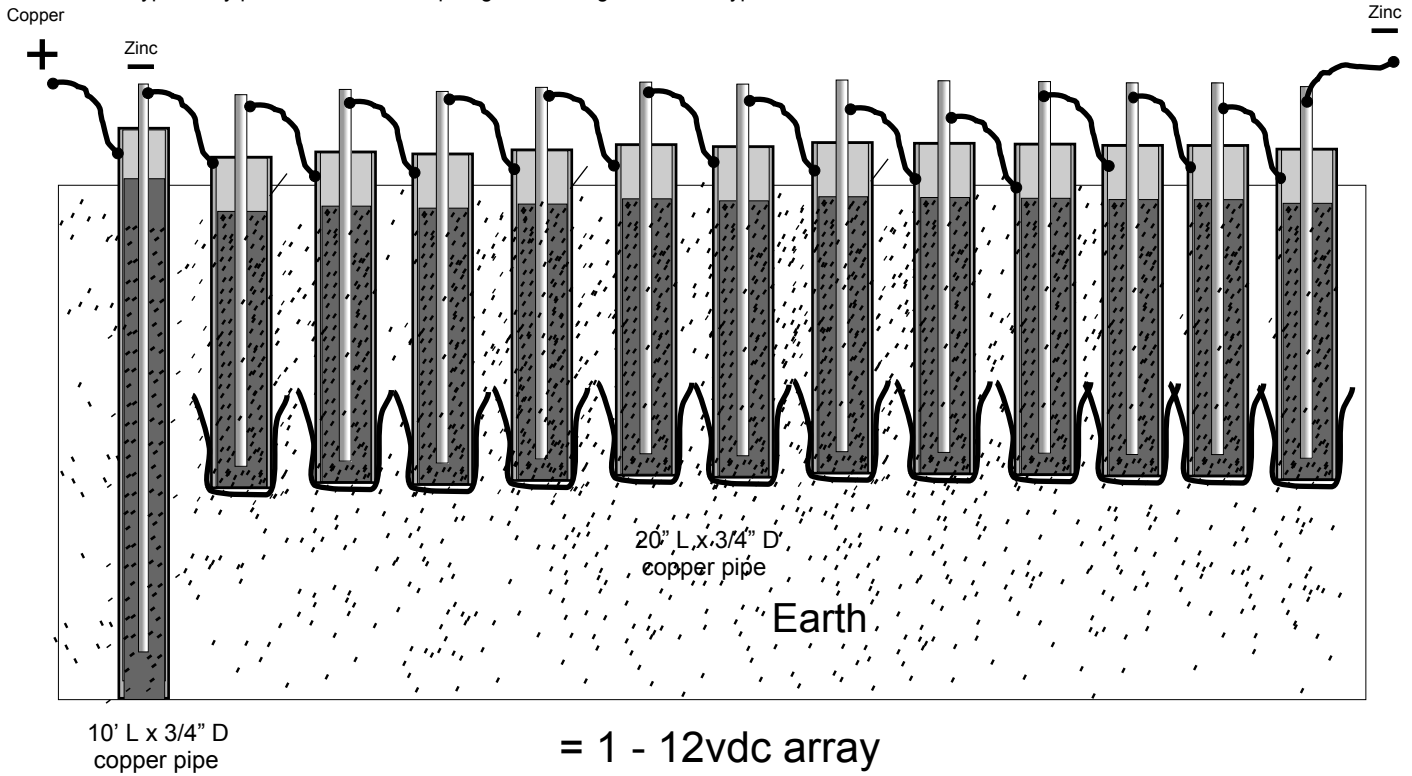

NOTICE: Do not paint the 10 foot copper cell. Keep all copper exposed to the earth. The more exposed copper the better. For higher amperage output, use a zinc or aluminum rod 10/16" Diameter which will leave a space of more than 1/16" to the copper.

Advantages of earth powered batteries

1. Free Energy
2. Long Life
3. The collection of aether energy.
4. Cells are also replenished by outside weather. Rain as well as lightning charges.

Learning The basic's of the invention

You can purchase Zinc rods or zinc plated bolts at any hardware store, most all nuts and bolts they sell are zinc coated and will work just fine. They also carry aluminum sheeting. Most hardware stores can order you copper sheeting as well.

Experiment #3 How to assemble a 12 vdc system

This is a simple way to produce more amperage but is not practical, we are only showing you this to educate you. The closer the zinc rod is to the copper the more amperage you will get as well as going deeper into the earth. If you do decide to build this basic set up. It is suggested that you solder all leads very well and dig deep enough into the earth to hide the tops of each cell. By covering the tops with dirt the cells can short out so what you want to do is to paint the exposed tops with lacquer or enamel paint then cover with plastic, cover with dirt and allow both the negative and the positive leads to stick out of the ground. But like I said this is not practical, what your goal should be is to make a very strong uf earth capacitor / battery, This will allow you to pick up and collect earth radiant waves of energy as well as lighting energy during storms, the energy you can collect in a strong lighting storm will amaze you! You must use an antenna on the zinc rod or copper rod. **WARNING! Be careful when collecting lighting it can kill you, be sure the positive and negative wires are not coming into your home. During a storm it is advised to have the lead wires going into a large uf cap bank via a one way diode on the positive lead to the positive of the cap or battery. The earth battery's can be dangerous at times and must be completely buried in the earth so a child, adult or animal can not touch or get to. Our earth capacitor batteries can store and hold thousands of volts. So be careful. Use rubber gloves and clothing to protect yourself. We are not responsible for anything in these plans you build at your own risk.**

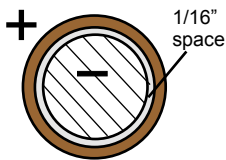

Example of a perfect Zinc rod copper pipe cell

Top view of a 12 volt dc array high amp system

Connect the series arrays in parallel to each other as shown. Or for a high voltage system connect all in series! Pulse the dc into a 10x step up transformer, 15,000 v Neon transf.

Zinc rod can be replaced by using rolled up aluminum sheeting or Zinc sheeting, Use 100% cotton cloth wrapped around the rolled sheeting or rod to give a small space in between the aluminum sheet and copper.



Learning The basic's of the invention

Experiment #4 The 6 foot spacing method (old way)

There are many US Patents that were Issued back in the 1800's, one of them was issued to a Mr. Deckman. Deckman found that if you take several small pieces of Zinc and Carbon rod and stick them into the ground next to each other and connect them in series (much like a battery) you get very liittle gain at all.

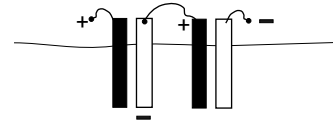

But if you put them 6 feet apart you will get a gain In voltage and they will not cancel one another out. so by doing this you can put them In series to increase your voltage and your volt amps. The theory is that there Is some sort of natural energy VORTEX that takes up about that much space for each unit or cell.

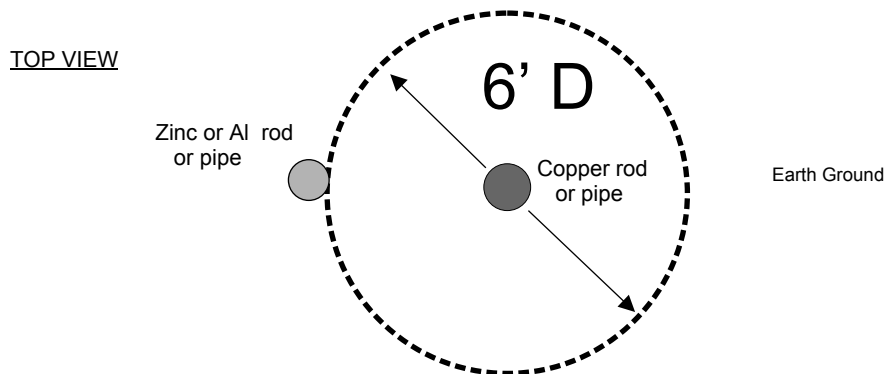

By using this method it will take a lot of ground space, ground space that many people just do not have with the exception of farmers. If you do have the space then think BIG! dig deep and have as many cells as you can get up to 2 to 4 acres. There are much better ways - vs - the old method as you will see. but by using Deckmans old way or our new methods, you can get as much free energy as you want with volt-ages or amperages as high as you want or desire. The higher the desired amperage the more costly it can get. We are always working to better our inventions to keep the cost down.

Learning The basic's of the invention

By using our new system you can get as much voltage or amperage as you want. Just size It to meet your needs or your budget.

How to get AC current for house hold use.

You can convert the incoming dc current to ac by using a home made inverter (which we sell the plans to, **5 kw inverter plans \$40 order #579**) or you can purchase a 12 v to 115 vac inverter from a store or solar panel supply house.. If you are planing to make a 115 VAC system this Is the only way you can do it. You can not get AC current from the ground. You must use our system to charge a deep cycle 12 v marine battery, and then connect our 5,000 watt 120 vdc to ac inverter to the battery to run your home. (we do not sell kits or inverters assembled, we only sell the plans at this time.)

More on the basic pipe method

Please note: the dirt level inside each pipe should be up to 1/4" from the top. each pipe should be tightly flilled with dirt. Which will automatically happen when you hammer the pipe into the ground the first time.

Each copper pipe (or cell) should be spaced 1 Inch to 1 1/2 inch apart. Doing this will give you more amperage and voltage.

How to dig a simple deep hole for 8' pipe: There are many ways in which you can do this. you can rent a ground drill bit and rig it up with a electric 2 hp motor or you can use 1" copper pipe.

First: prepare the ground with water to make it moist but not muddy, 2nd: hammer a 1" x 5' copper pipe into the moist ground about 5 inches deep/ then remove it from the ground and take a stick or a water hose to remove the dirt from inside the pipe. Then just repeat the process over and over until you get the desired depth that you want. you can get about 10 feet or more using this method.

WARNING! BE CAREFUL OF ELECTIC POWER LINES WHEN YOU PLACE OR PULL THE COPPER PIPE FROM THE GROUND, IT WILL KILL YOU IF YOU TOUCH A POWER LINE WITH THE END OF THE COPPER PIPE.

We are dealing with a new type of energy as well as conventional energy < Ether energy can go through rubber/ plastic. Iron, etc....

What is ether or Radiant energy?

The understanding comes from a very deep study of etheric or static forces, this energy that we are getting out of the ground is what some call LIGHT ETHER, when you separate the light ether from the warm ether you can get these superconductive events. It appears like electricity but it has no heat events related to it.

The point is that the best polarity's of things to get a differential in the light ether is to have a silvered coloured metal and then something that is totally absorbitive/ Like black Carbon.

So now you have something that's the perfect reflector and something that is the perfect absorber, and once you understand what your pulling out of the ground (and that it is not classic electricity as we get out of a normal type of chemical battery), then your going to be farther down the road to understanding how to get much more power out of this stuff.....

There are researchers now that are getting 1 /2 volt to 2 volts dc on a "Quote" volt meter, but it will shock you through an inch of rubber shoes this is not normal electricity!

Q: Is this energy coming from the sun and being absorbed In the earth or from the center of the earth?

A: Yes, but the primary source of light ether is the sun light, yes the earth does have an economy of light ether which does follow the sun around. BUT IT IS ALSO IN THE GROUND! AND ITS IN THE AIR!

Q: Did NokolaTesla know about this in the 1900's?

A: Yes, if you read into his writings he was always saying things like, there is more energy moving than just the electricity in this stuff.

Example: If you take a large Tesla coil and fire it up, and you drive it with a van de graph generator and you put the output of that into a Tesla coil. you can throw sparks across the room! What these electrostatic machines are gathering is light ether.

A Very Strange and New Discovery!

While working outside on another experiment I discovered a very strange generator effect, much to my surprise, I found that by using 2 aluminum 8" disks connected to my DC volt meter and by placing both disks in a vertical position while touching the bare earth dirt, and moving one of the disks and allowing the other to be stationary I get a dc voltage positive output! This effect works with any size or shape of aluminum, we used 8" diameter disk x 1/8" thick, we found that size to work best. Also by stacking them like a capacitor you will find that the current output is far greater, For Example: see figure 1, Disk A would have 4 more disks connected in parallel of the same size separated by paper die electrics. The same goes for Disk B .

First find a spot any where on the ground where there is no grass (best when wet). Please note, it's not just creating an acid battery effect, you are also getting a good contact with the ground as a conductor to pick up ether energy.

Now place the disks side by side, attach your DC voltmeter probes onto the disks, one negative and one positive. DC meter should be on the lowest setting, now place both disks on the ground very softly and move **disk B** and **do not move disk A** (positive.) You will notice you are getting a small amount of voltage and amperage. Now Move **disk A** and do not move **disk B**. **THE POLARITY CHANGES**.

The rule here is; The disk that moves is always positive. since we can get a polarity change just by moving the disks at opposite times. You can make a very simple mechanical device to get AC current from on top of the earth. Again, this is not just a chemical reaction we have done many test to prove this. You can also get a small voltage reading in dry dirt. The reason for the smaller voltage in using dry dirt is because a low conductance resistance is taking place here, keeping the system from being in contact with the earth and collecting the earth **ether energy**.

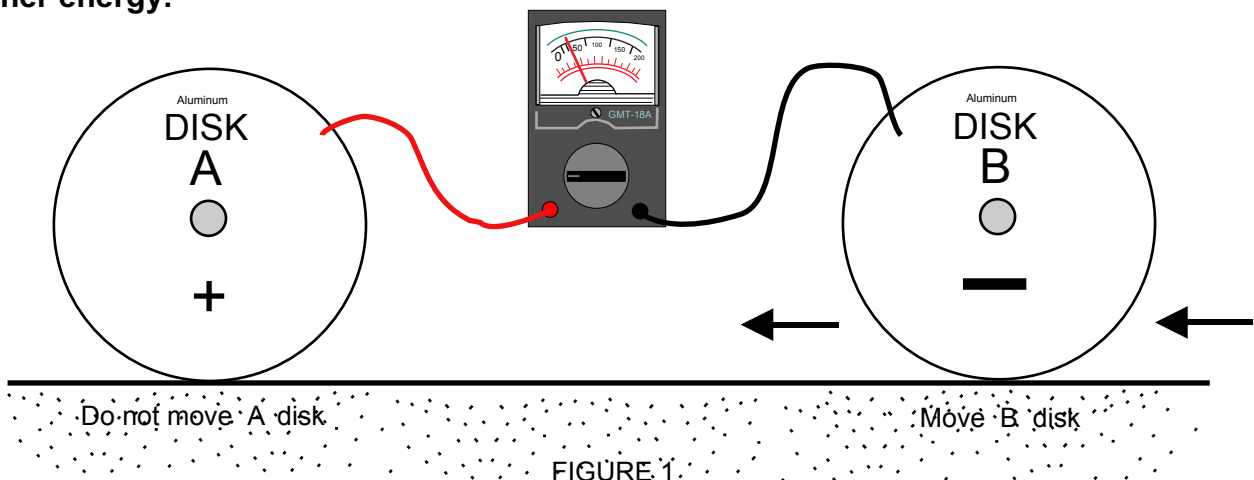

Capacitor Sheet Method

This method is far better than using pipes or rods. By using copper and zinc or aluminum foil sheets you will get much more amperage out of your system!

The amperage you will be collecting will be coming from 3 different sources,

- 1. The acid in the ground and water**
- 2. Energy that is being transmitted from the earth itself**
- 3. Energy that is being transmitted from the sky and space.**

This may all seem unbelievable but it's true and is a fact! The more plates that you add the more power you will get! The copper sheet(s) is the positive, it must be facing down toward the earth. The aluminum or zinc sheet(s) is the negative and must be facing toward the sky! Between each sheet place 1- cotton or coarse screen printing mesh or other plastic coarse mesh cloth material. you can use a hole puncher to punch exact holes in each sheet, use 2 holes per sheet copper and aluminum. Use a 8 1/2" x 11" paper puncher one that is adjustable. next use a 3/4" wood base and drill hole for wood dowel rods to fit to the holes you punched in the sheets, you will have a total of 4 wood dowel rods, 2 on the right for the copper sheets and 2 on the left for the aluminum sheets to fit over, cloth die electric can be done the same. You then need to assemble dry and use another 3/4" wood board for top holding plate, which will fit over the wood dowel rods on top, sandwich and press the assembly together and tape in place with duct tape, drill 2 long bolt holding holes on bottom wood base and top wood base then attach long bolts and nuts and tighten down. Remove tape. and attach wires, water the entire capacitor assembly and bury in the ground.

Copper sheet



Top View

Aluminum sheet

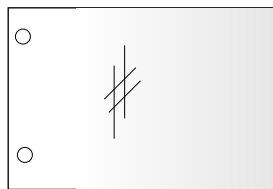

Top View

Cloth sheet

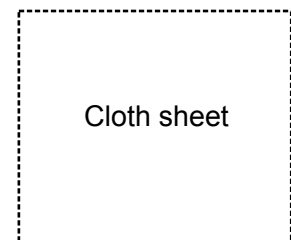

Top View

Place Aluminum sheet on top of copper sheet

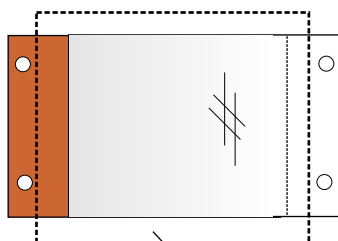

Dotted lines indicate where cloth goes

Top View

Wood base with wood dowel rods

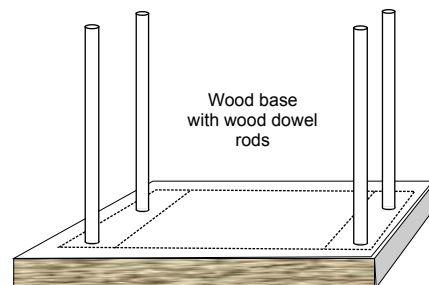

Side View

Capacitor Sheet Method

10' Antenna

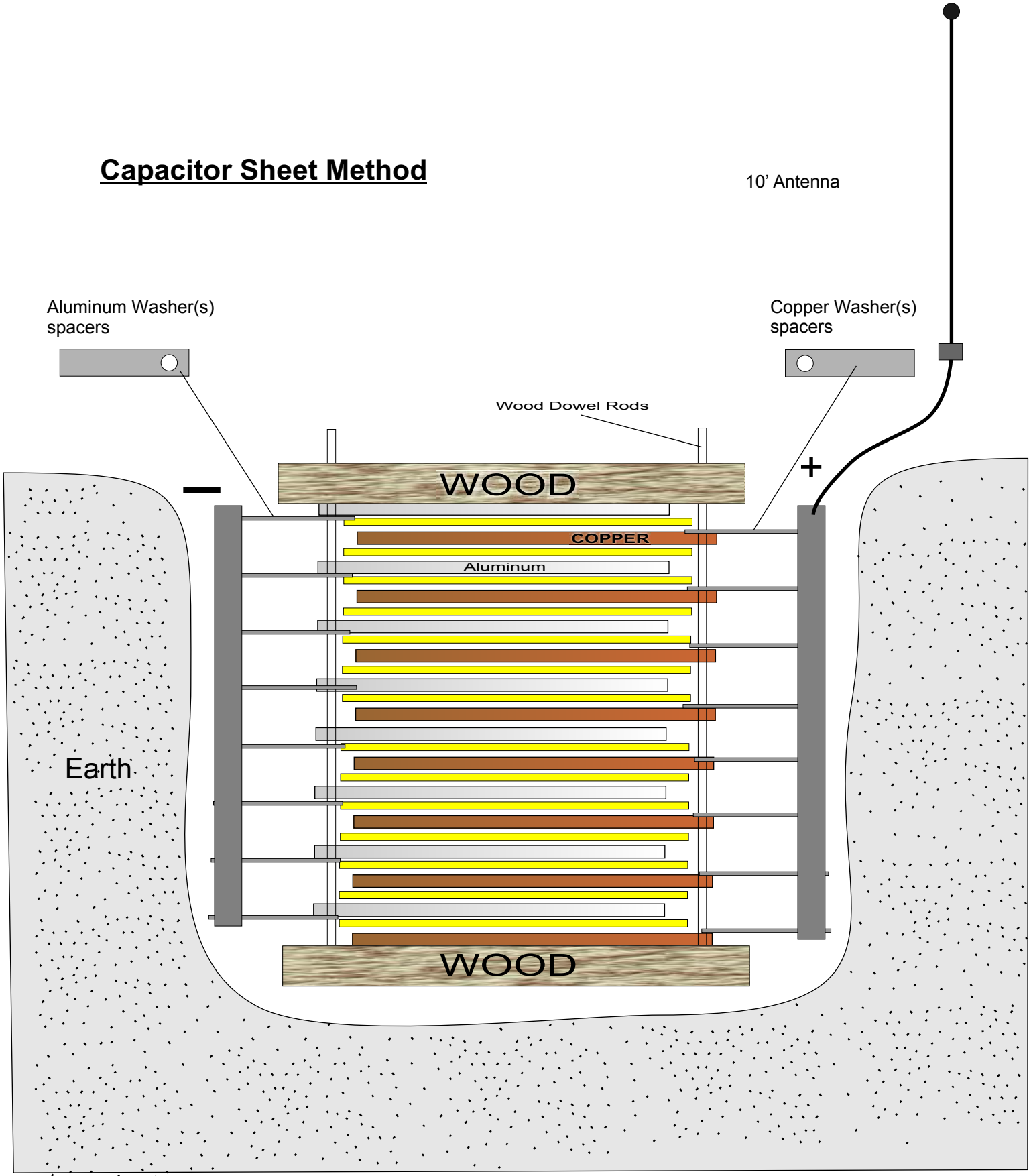

Aluminum Washer(s) spacers

Copper Washer(s) spacers

Wood Dowel Rods

WOOD

COPPER

Aluminum

Earth

WOOD

+

-



Capacitor Sheet Method

Again, the more plate sheets of metal you add (or cells) the more power you will get! Remember it's all about capacitance. You are collecting more than just simple battery type power. The copper plate sheet is the Positive + and the Aluminum sheet is the negative. There are many ways in which one can build this type of earth energy collector, below is simply an example of another shape and form. In this type we use water holes. water holes must all be in exact spots.

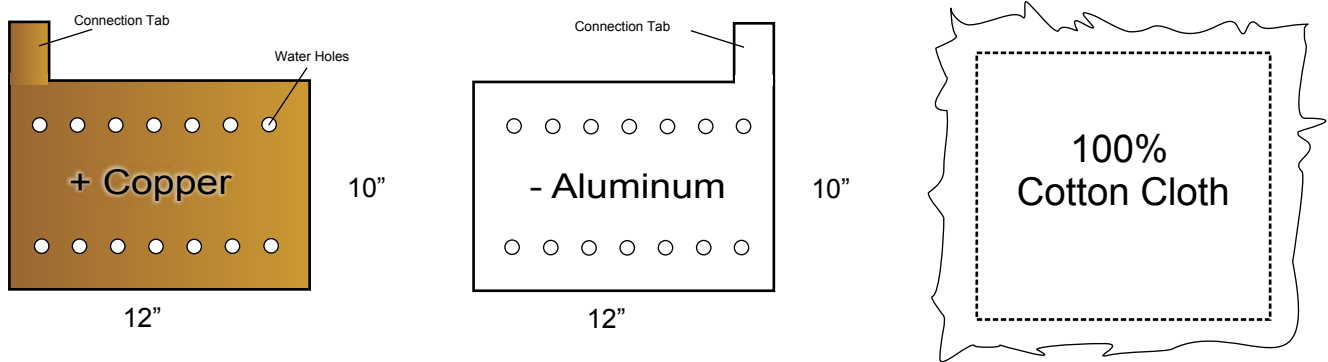
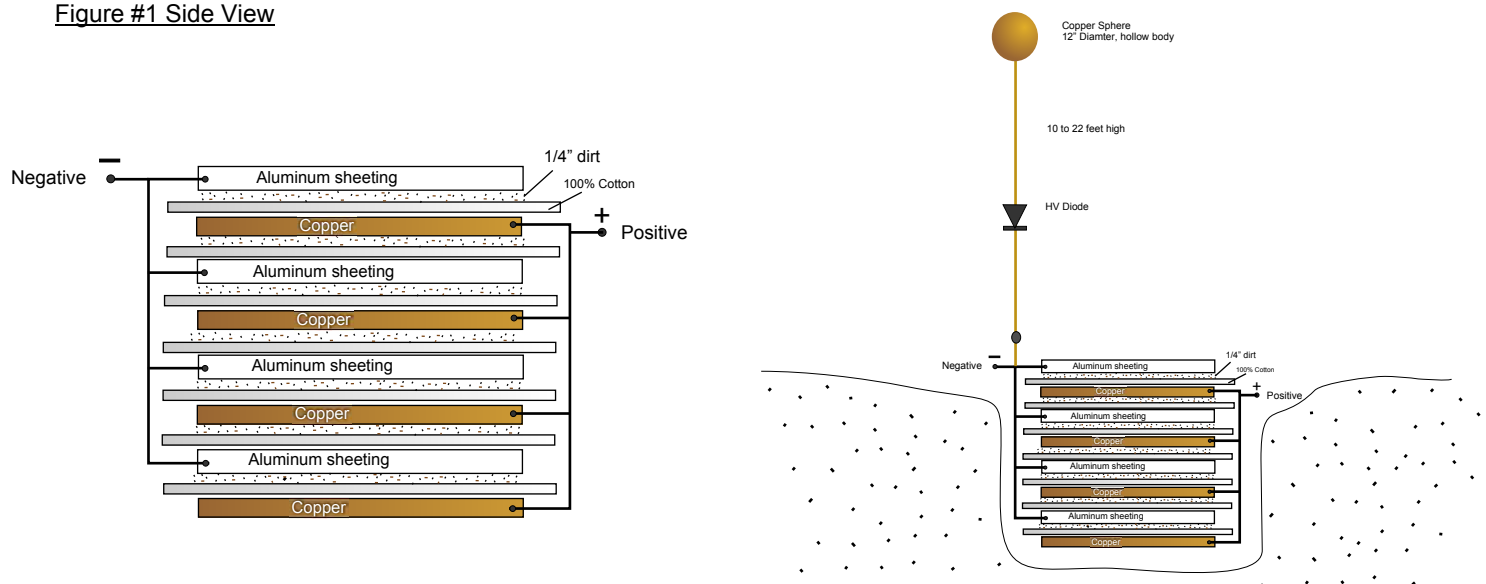

Figure #1 Top View of separate pieces

Figure #1 Side View



OUR MORE ADVANCED EARTH CAPACITOR!

(EECC) Earth Energy Coil Capacitor!

To collect more ether earth energy atoms, build the following **Earth Energy Coil Capacitor**. This is far better than anything we have found yet! Much more power and is easier to build.

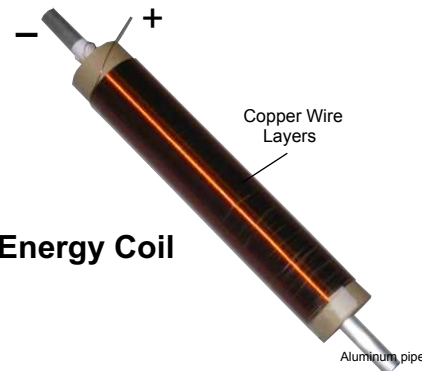

Start with our EECC Model #1, Take a 5/16” zinc rod or aluminum rod, cut to 7.5” long. Now use #27 bare copper wire, secure it in a drill press (which you will then turn by hand). Cover zinc rod with paper one layer, use very tiny bits of tape to secure. Now apply the copper wire over the paper, remember to use copper that is not coated! Tape one end of the copper wire to the end of the zinc or aluminum rod and begin to slowly wind. Each wind must be perfectly fitted side by side, paper should be 5.5” long, total length of winds should be 4” long centered on paper. Once you are done with the first layer, apply another piece of paper to the top layer of the first copper layer, do not use too much tape to secure paper in place! Now begin your 2nd layer, repeat this same process until you have about 10 layers, (the more layers the better!) Copper must not touch the zinc or aluminum. When done hot glue or epoxy a small end piece of the copper wire so it will not come unwound. This is one complete cell, keep in mind this is a small test version, to get more power you have to THINK BIG! Build larger cells, using larger size copper. Then place them in salt water to test, 2 cells can be connected in series, after that you must connect them by use of capacitors, diodes and electronic or hand wound spring switches. If you build 20 of these and try to connect them all in series without a cap/ diode switching method, the cells will cancel each other out. Keep in mind you want water to get to each layer as well as the zinc or aluminum. You can also use Aluminum or zinc pipe.

Now concerning the paper Die Electric, Paper will not last very long, test and find a water absorbing plastic die electric,(mesh type). We suggest that you use Plastic screen mesh that you can buy at any hardware store, if all you are interested in is collecting small voltages then use one layer in between each layer of copper, if you are interested in collecting higher voltages such as lightning charges then you must use more layers of plastic screen mesh to thicken the die electric so the higher voltages will not short out your system. Paper may not last longer than 1 year, Plastic screen mesh or polyester screen printing mesh will last for many years.

EECC Model #2 Same as #1, but different. In this design we use #27 copper COATED wire, instead of bare wire. since the copper wire is coated and not bare, each layer must be sanded, that is, the top portion of the copper coated layer must be sanded off so it will be exposed to the water and acid, a die electric should still be used in this case. This type makes for a very high efficient earth cap!

EECC Model #3 Same as #1 but reversed! You will use aluminum wire and a copper rod or pipe. Use a 3/4” copper pipe and wind the die electric paper or plastic mesh and Aluminum bare wire around the copper pipe as explained in Model #1

OUR MORE ADVANCED EARTH CAPACITOR!

(EECC) Earth Energy Coil Capacitor!

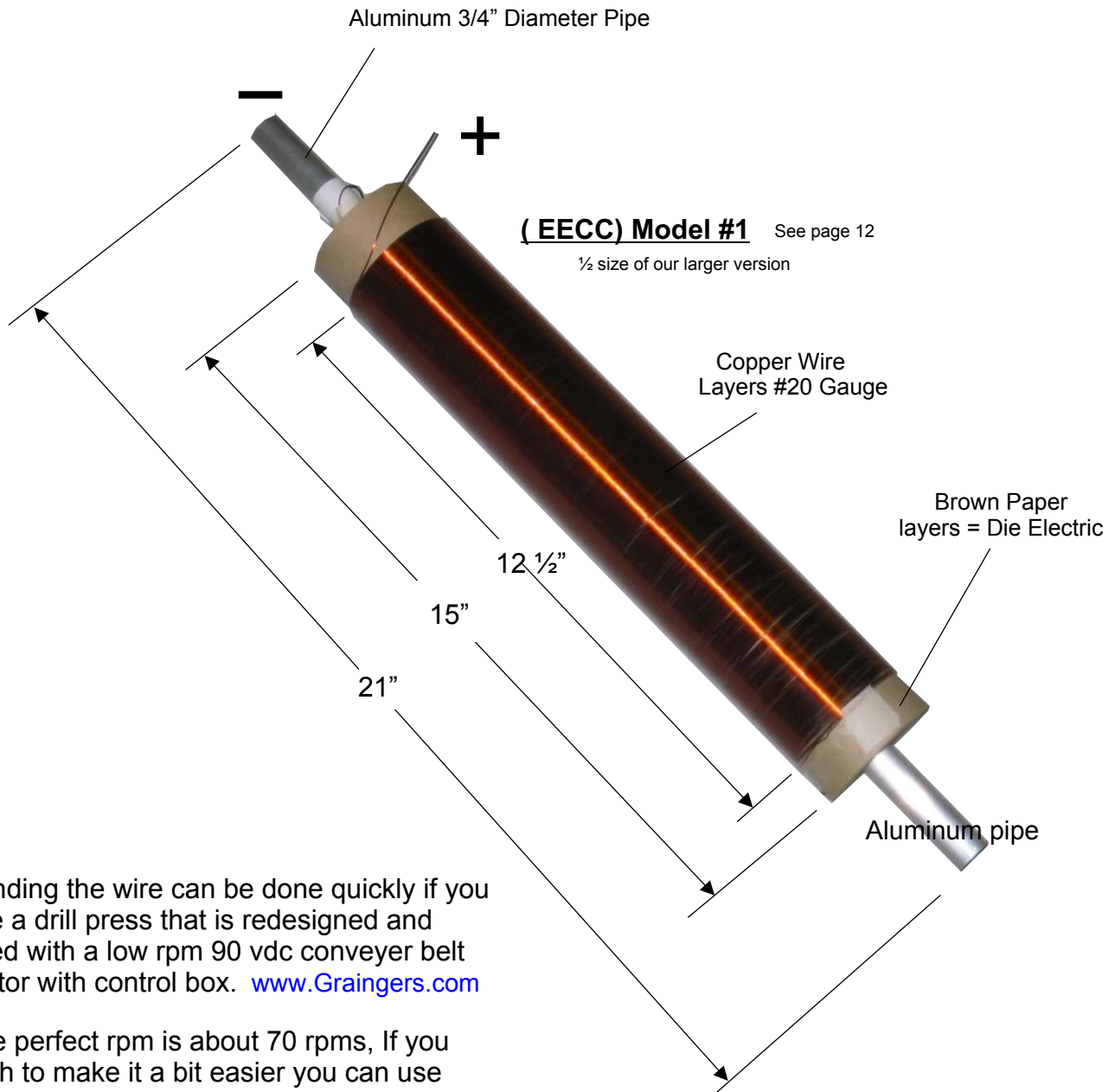

Winding the wire can be done quickly if you use a drill press that is redesigned and fitted with a low rpm 90 vdc conveyer belt motor with control box. www.Graingers.com

The perfect rpm is about 70 rpms, If you wish to make it a bit easier you can use larger wire such as # 17 gauge. The photo is an example of a mid size cell and can be very powerful! This is ½ size of a large cell.

OUR MORE ADVANCED EARTH CAPACITOR!

(EECC) Earth Energy Coil Capacitor!



Our small test model #1, we used #22 bare copper wire wrapped around a zinc rod, each layer had a paper die electric, tested in tap water. 5 layers.
Output = 89 vdc x 3.5 ma, this is low.
more layers will = more capacitance which =s more amperage and voltage.



Small Drill press turned into a Coil Winder

The more layers, the more free earth energy you can collect!

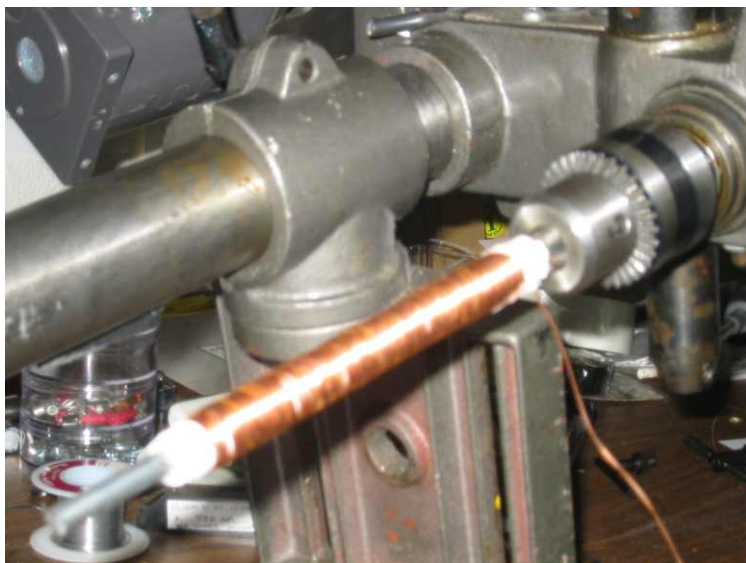

Small Drill press turned into a Coil Winder. We turned this by hand.
Larger coils is best to use low rpm motor at about 70 rpms, In this picture you see that we wound each wind side by side, this makes for a more high efficient earth cap.
You can wild wind if you like if you use smaller wire like #31 to #34.

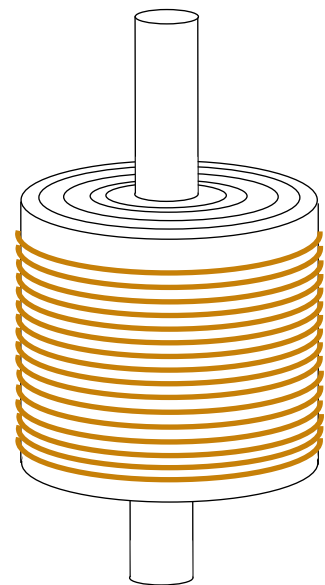

Side View
Ideal size for experimenting

MODEL #4 Rolled Earth Capacitor

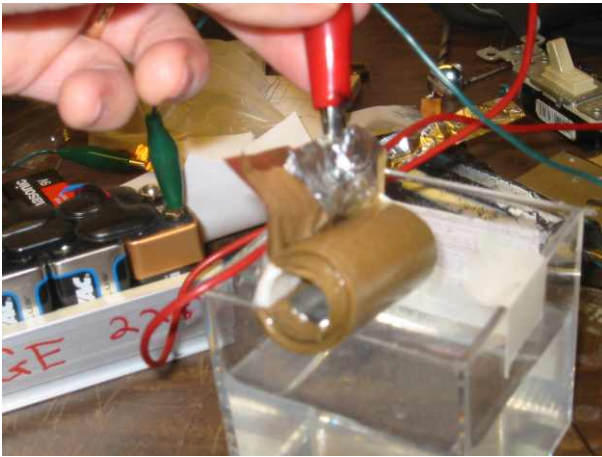
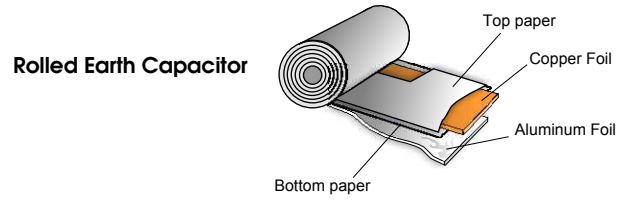

(EECC) Earth Energy Coil Capacitor!

MODEL #4 Rolled Earth Capacitor

Rolled Earth Capacitor

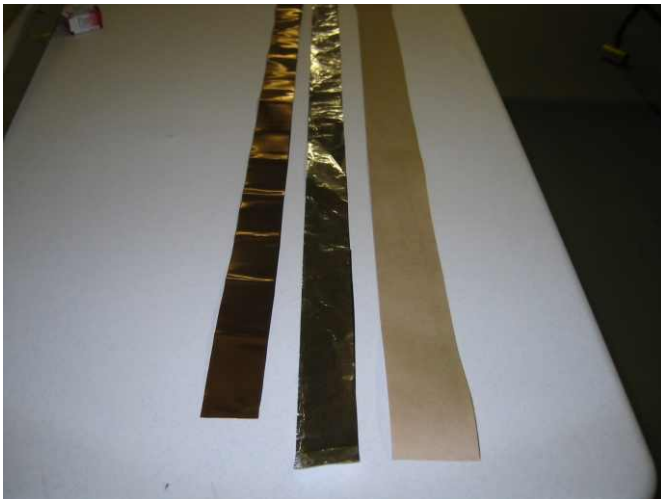
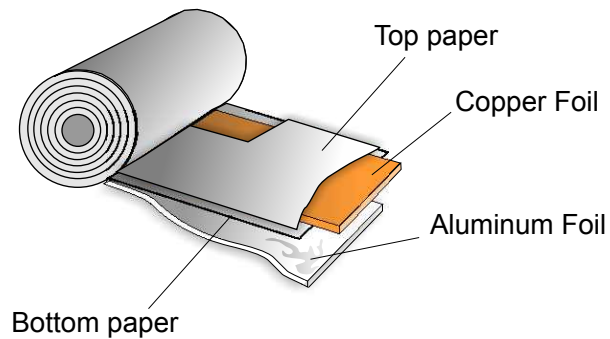

Again rolling this type of earth capacitor is very hard, Everything must be kept straight and inline with one another, Manufacturers of rolled electrolytic capacitors use computers and machinery. I am sure a simple home made roller with pin registration could be designed very easily. This type of earth battery is very high efficient. Paper is not a good die electric for high voltages! If you are wanting to collect earth and storm HV Currents you must use a thicker die electric. Metals must be spaced properly for storing high voltage.

(EECC) Earth Energy Coil Capacitor!

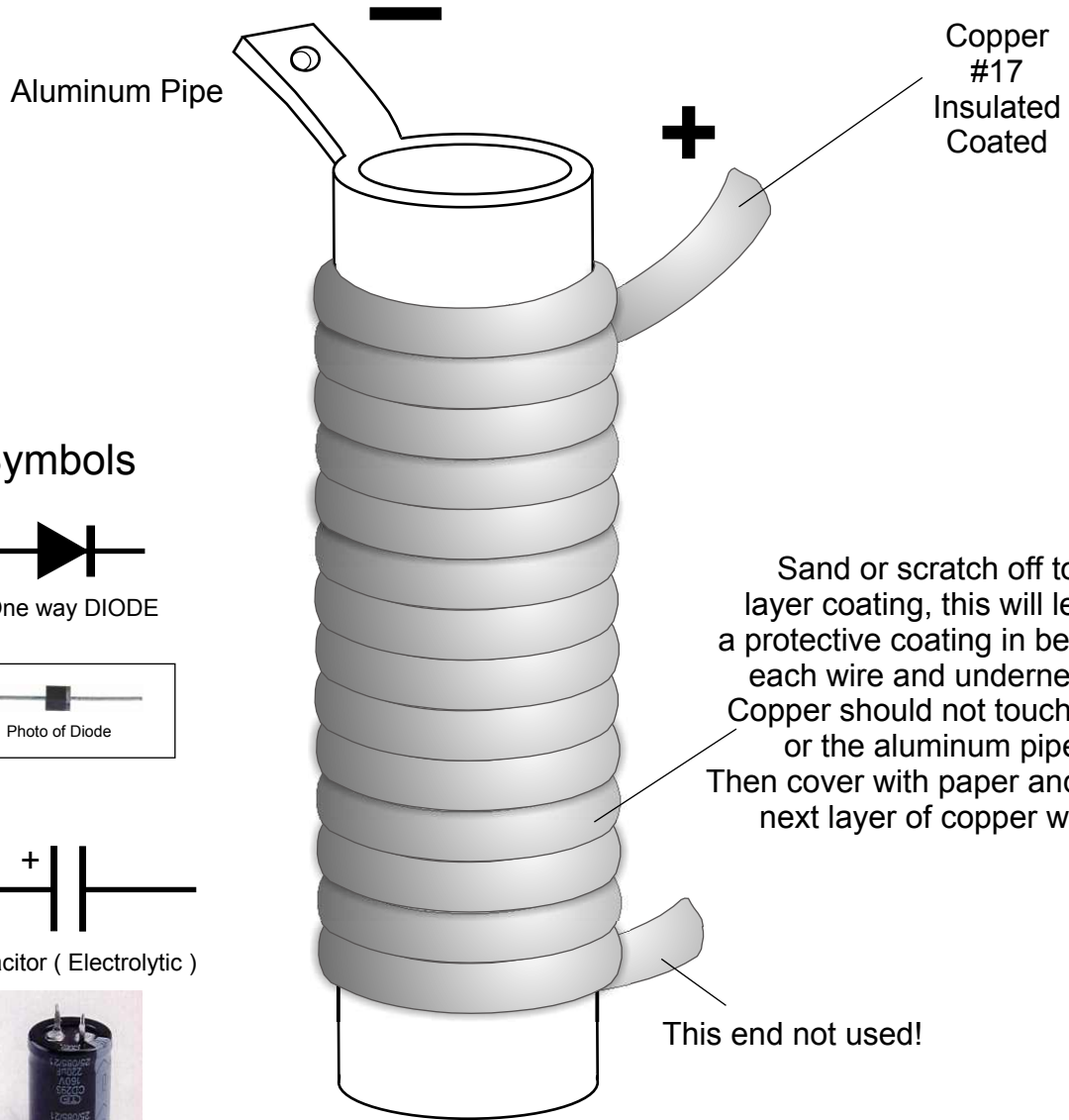

Symbols

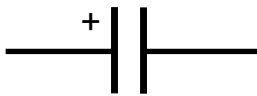

Capacitor (Electrolytic)



Sand or scratch off top layer coating, this will leave a protective coating in between each wire and underneath. Copper should not touch itself or the aluminum pipe. Then cover with paper and begin next layer of copper wire.

This end not used!

CONNECTING THE CELLS IN SERIES

How to connect the cells in series to increase the output voltage without allowing the cells to cancel each other out. **Figure A** The Copper pipe and zinc rod method without the use of plastic on bottom of pipe. **Figure B** is the coil earth cap method.

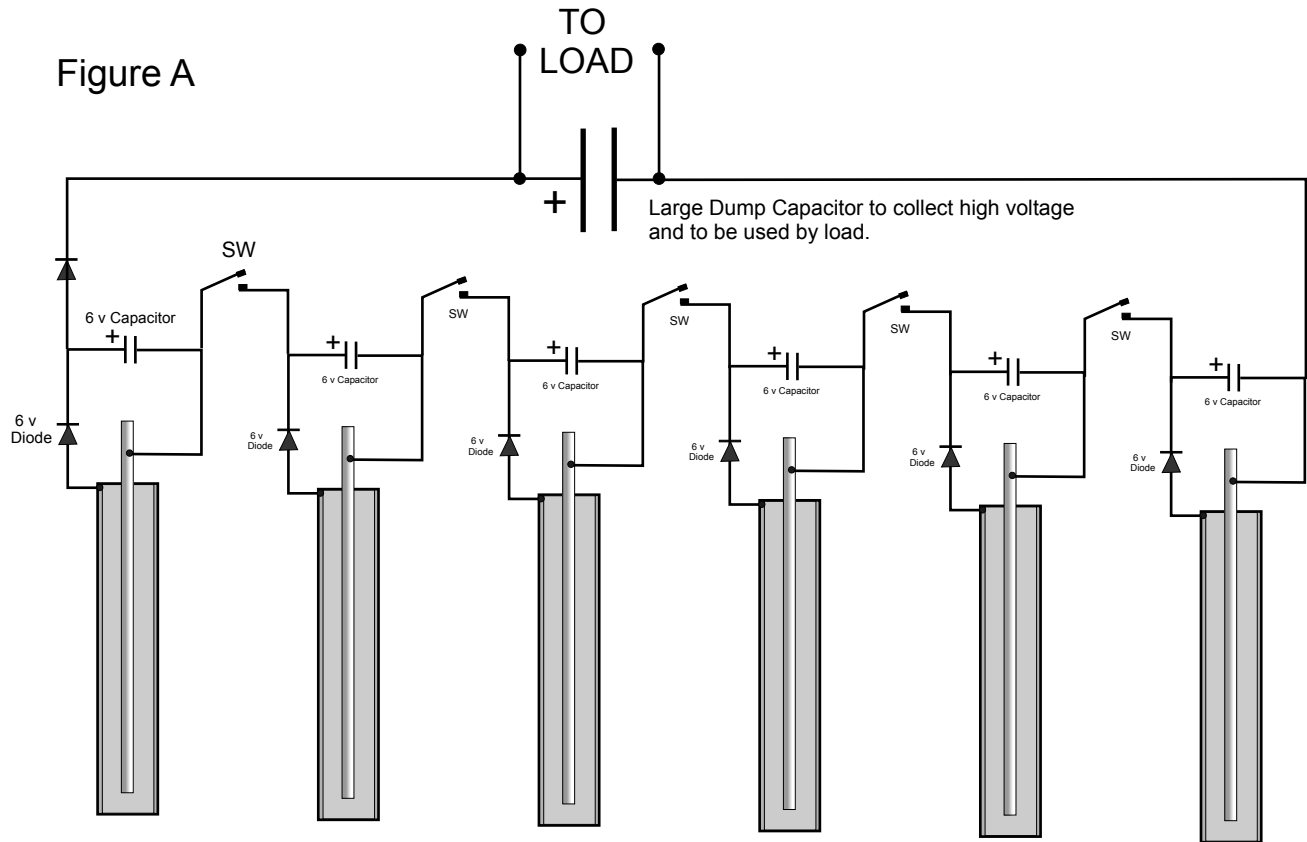

Use electrolytic capacitors to store the charge coming from each cell, then connect them in series using Commutator Sw's connected to a small rotor shaft, connected to a milliamp solar cell hobby motor or build a small fuelless engine electric motor to run on and off switch's. You can also build a very low milliamp electronic switching circuit and use the earth energy to power it. Or another more simple way would be to use a hand spring type device (timer type) glue small magnets on a long rotating rotor arm connected to the inner spring. Then place small reed relay magnetic switches, on each timing magnet ON position. should have multi reed sw's, as the unit turns if gives time for the caps to charge and then comes around and connects caps all in series which in turn discharges into main cap dump.

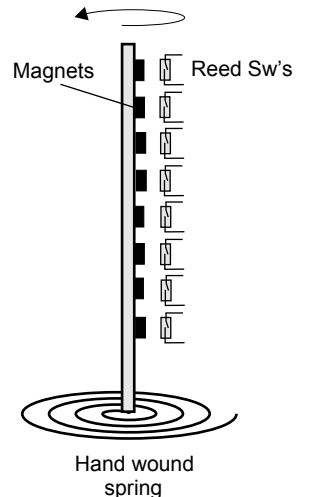

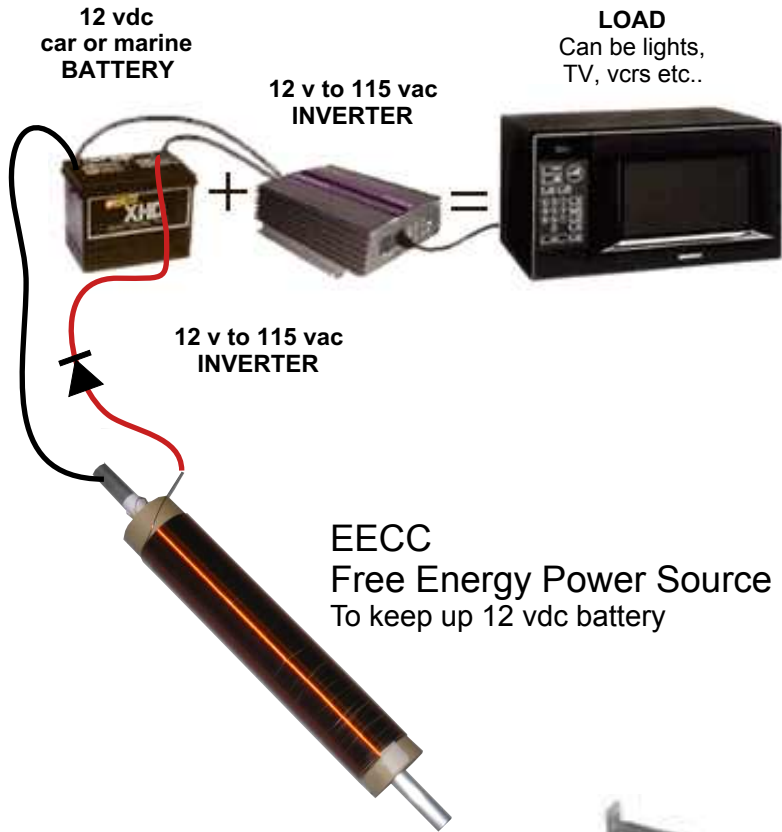

Copper



Symbols

= One way DIODE

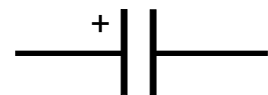
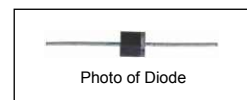

Capacitor (Electrolytic)



Photo of one type of Capacitor



Suppliers List

Free News



See www.google.com



1. [Http://www.delphiglass.com/](http://www.delphiglass.com/)

Use there search engine to find copper foil tape

2. http://www.glassmart.com/foil_menu.htm

3. <http://www.globalsources.com>



Search Google.com for:

1. Copper flashing
2. Inverters
3. Batteries
4. Copper coated wire
5. Copper wire
6. Electronic parts and supplies
7. Diodes
8. Capacitors
9. Free energy from the earth
10. Zinc rods



EECC update

Step One

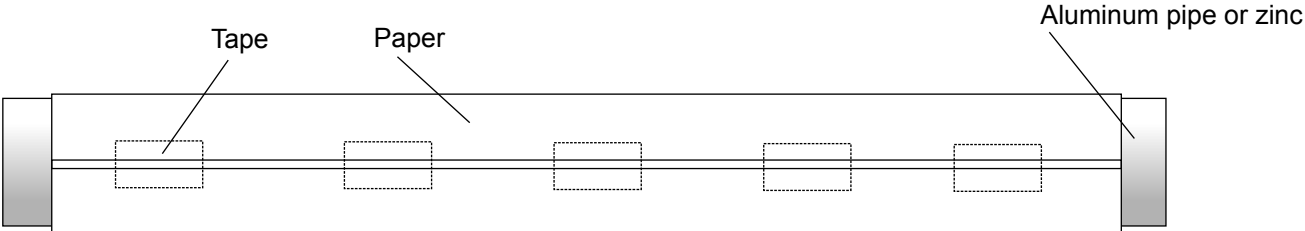

Step two

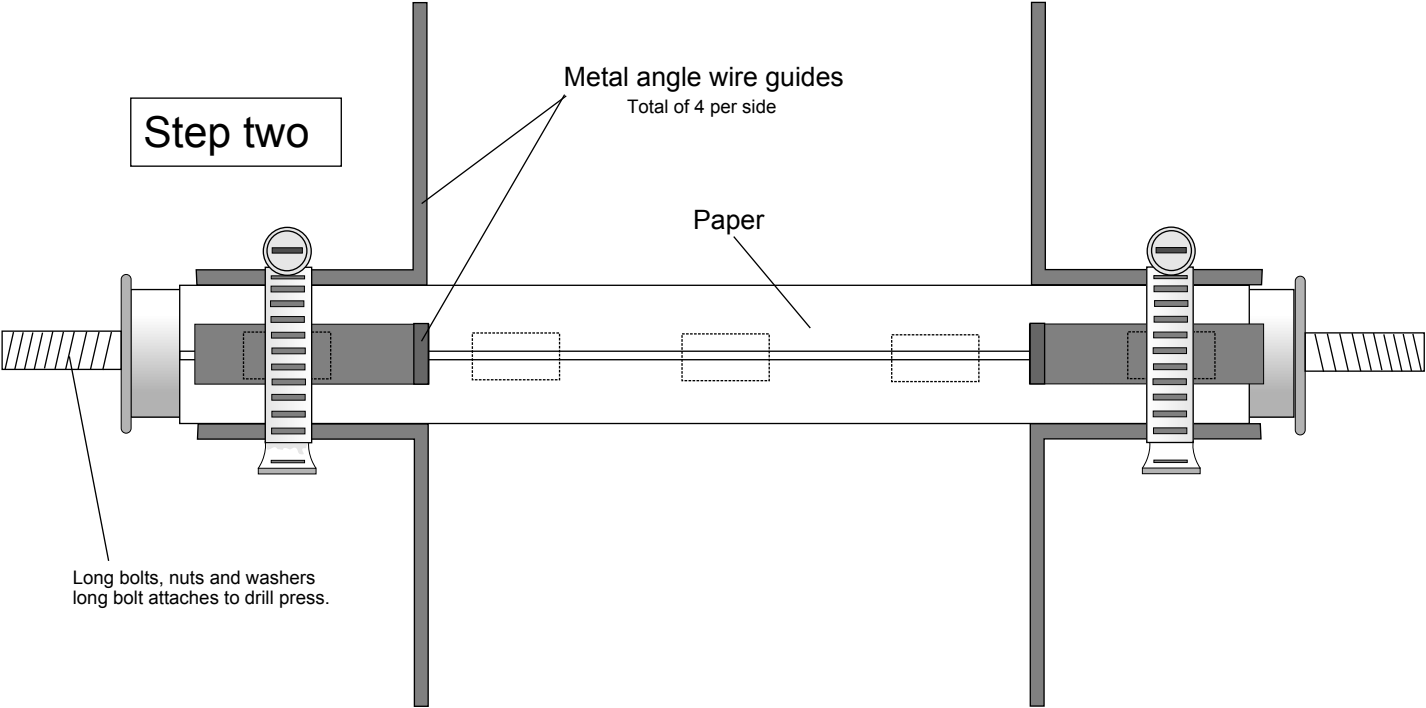

Apply first layer of wire, remove, metal wire guides, apply more paper, then repeat over and over again until you have about a 5 to 6 inch diameter roll of wire and paper. Makes a very powerful earth capacitor!

EECC update

These are just a few extra ideas that we threw together. I hope they are helpful to you. Let us know how you like these plans. Send us photo's of what you have done we love to hear from our customers. If you got any new free energy idea's let us know we can research them for you. Many customers do not have the extra research time that we have.

